



**SONY**

 **Optical Disc Archive**

Set to revolutionize video and data archiving



## Optical Disc Archive

Over the past few decades, movie studios, broadcasting networks, and production houses across the world have accumulated a massive quantity of tape. To manage this, the industry has an immediate need for a reliable, easy-to-operate, cost-effective file-based archive system.

Sony's Optical Disc Archive storage system offers the solution, with a low total cost of ownership through the use of long-life media, and it includes inter-generational compatibility based on the same optical disc technology used in DVDs and Blu-ray discs.



# Hollywood Film Archiving

The modern motion picture business does a very comprehensive and reliable job of archiving feature-length motion pictures using film archives. But looking back over the past 100 years, Hollywood's history of archiving has been uneven. Many of the earliest movies have been lost because long-term preservation of motion pictures was not considered important - either commercially or culturally. Many titles in early film libraries on flammable nitrate stock were destroyed by fire or merely thrown in the trash; other generations saw their film masters turn to "vinegar" in hot, humid warehouses until current climate control requirements for long-term film preservation were well understood. As a result, fewer than half of the feature films made before 1950 have survived, and less than 20% have survived from the 1920s [US, LC, NFPB, Natl. Film Preservation Plan].

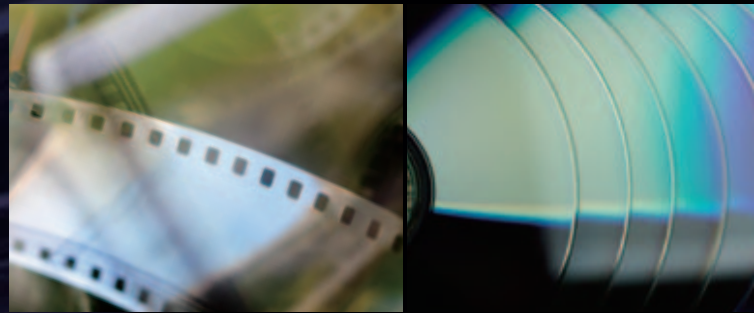

# Why data management is important

Today, files can be lost from computers in any number of ways—you might accidentally delete a file, a virus might wipe one out, or there could be a complete hard drive failure. When a hard drive dies an untimely death, it can feel like a house has burnt down. Important personal items are usually gone forever—photos, significant documents, downloaded music, and more.

There are many options for backing up content, without any sophisticated equipment—you can use DVDs, external hard drives, optical discs, or even online storage. It's a good idea to back up data to multiple places.

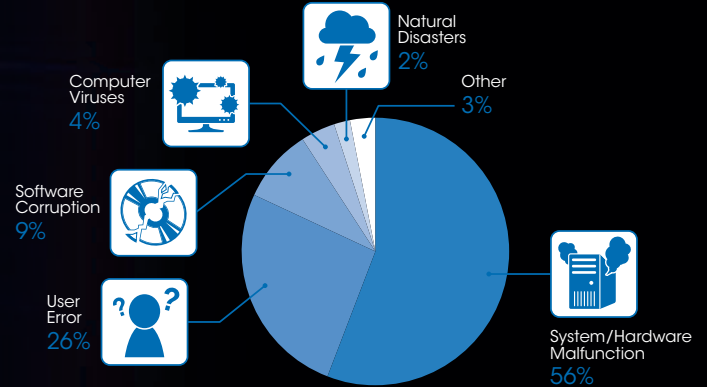

Source: Ontrack Data Recovery  
[www.ontrack.co.uk/understandingdataloss](http://www.ontrack.co.uk/understandingdataloss)

# Optical Disc Archive

An entirely new optical disc-based storage system is the Optical Disc Archive. It's based on Blu-ray technology, but inherits some key attributes from Sony's Professional Disc (XDCAM) format. The system involves the use of multiple bare discs contained within a very robust cartridge and a dedicated disc drive unit with an associated software driver able to manipulate discs individually—providing a seamless read/write capability.

## Advantages

### 50+ Years Archival Life

Optical disc technology is extremely robust and average media life is estimated at around 50 years, which is substantially longer than other storage media on the market.

It also guarantees intergenerational compatibility, which reduces future media consumption and avoids the risk of data corruption associated with frequent data migration.

### High Reliability

By its nature, optical disc technology is highly durable and resilient in a wide range of environmental conditions. The simple structure and the robustness of the media make it ideal for shelf archiving and material exchange.

Furthermore, since this system doesn't require frequent data migration, you can protect your valuable data from corruption that typically occurs during data migration.

The drive comes with functions to verify written data and recover from various errors such as file read/write or mount errors, or lost files.

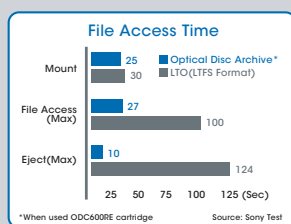

### Low Total Cost of Ownership

To keep the cost of media asset management to a minimum, the system is designed to be simple, affordable, and eco-friendly. Moreover, with its longevity and generational compatibility, coupled with low power consumption and a wide range of acceptable storage conditions, the Optical Disc Archive system significantly reduces the total cost of ownership.

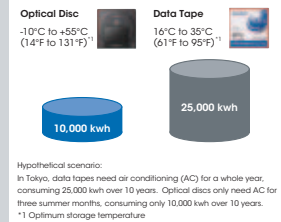

### Open Platform

We make the platform open, and have established alliances with industry partners with a view to promoting further utilization of the technology and enhancing the system through collaboration and multi-sourcing of key components.

\*The following manufacturers have already expressed their support for the Optical Disc Archive:  
Adobe, ASG-Atempo, AVID, Dalet, Front Porch Digital, Harris, Qstar, SGL, Square Box Systems Ltd, Vizrt

## Optical Disc Archive Cartridge



A variety of high capacity media cartridges are available for the Optical Disc Archive System, From 300 GB to 1.5 TB, Write-once and Rewritable, you can select the media capacity that best fits your workflow.

### ■ Mass storage media with proven optical disc technology

The cartridge contains 12 discs that appear to the user as one volume of mass storage. The file format is UDF (Universal Disk Format). Each cartridge allows random access to files and high speed data retrieval.

\*The cartridge cannot be opened by users.

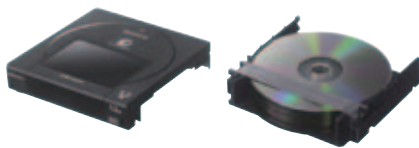

### ■ High Reliability, & Durability, Optimized for long term archiving.

The non-contact read/write technology of optical disc enables high reliability. Optical disc technology is extremely robust with a media archival life estimated at 50 years, substantially longer than other storage media in the market. The cartridge is designed to be highly durable and resilient in a wide range of environmental conditions. This enables you to store the media in the typical office environment and does not require special climate controlled conditions.

\*Estimated average archival life based on internal acceleration testing.

### ■ More Convenient, Efficient Asset Management

The media has a built-in "Cartridge Memory". The built in "Cartridge Memory" provides seamless integration between the cartridge and drive by storing basic content recording information. With the future release of application software, the cartridge memory feature will allow users to identify the contents of the media with mobile devices for efficient asset management, such as cartridge tracking and digital asset inventory control.

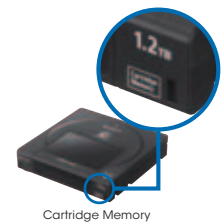

Model Name	ODC300R	ODC300RE	ODC600R	ODC600RE	ODC1200RE	ODC1500R
Media Type	Write Once	Rewritable* <sup>1</sup>	Write Once	Rewritable* <sup>1</sup>	Rewritable* <sup>1</sup>	Write Once
Capacity* <sup>2</sup>	300 GB		600 GB		1.2 TB	1.5 TB
Recording time* <sup>3</sup> MPEG-2 HD@22.5Mbps	8.5 Hours		18.5 Hours		38 Hours	48 Hours
Rewritable Cycles	-	More than 1,000 times	-	More than 1,000 times	More than 1,000 times	-
Read Cycles* <sup>4</sup>	More than 1,000,000 times					
Operation Temperature	5°C to 55°C (41°F to 131°F)					
Storage Temperature/ Humidity	-10°C to +55°C (14°F to 131°F) / 3% to 90% RH (Short term Transportation condition) 10°C to 30°C (50°F to 86°F) / 30% to 70% RH (Long term Recommended )					
Estimated Archival life* <sup>5</sup>	Less than 50 years					

\*1: Only the index reference is changed when the user deletes a file and the capacity on the disc is not restored, unless it is last recorded file on disc. The initial capacity can only be restored by re-formatting the cartridge.

\*2: Recording capacity depends on the usage environment. Actual recordable capacity may be smaller than indicated on the cartridge.

\*3: The recording time is for reference only and based on a fully recorded disc at the specified data rate.

\*4: Read cycles = Number of time for reading data in the disc.

\*5: Estimated average archival life based on internal acceleration testing.

# Optical Disc Archive Drive

ODS-D55U Drive  
ODS-D77U Drive



A starter system ideal for the camera owner / operator or a small studio is Sony's single-user solution, the stand-alone drives. This USB 3.0 drive plugs directly into compatible Macintosh and Windows computers. It's the desktop solution that is ideal for long-term file protection and management, and an easy choice because each 12-disc cartridge functions as a single unified volume.

## Main Features

### Fast Transfer Speeds

ODS-D55U with transfer speeds of 330 Mbps (read) and 210 Mbps (write-once disc)

ODS-D77U more than doubles the read and write speeds of the ODS-D55U

		ODS-D55U	ODS-D77U
Read		330 Mbps	1.1 Gbps <sup>*1,3</sup>
	Write Once	210 Mbps	730 Mbps <sup>*1,3</sup>
Write <sup>*2</sup>	Re-writable	130 Mbps <sup>*1</sup>	300 Mbps <sup>*1,3</sup>

<sup>\*1</sup> Performance is varied based on type of cartridges.

<sup>\*2</sup> Write performance is halved in write-verify mode.

<sup>\*3</sup> These values are subject to change.

- 50 year rated media - write-once (WORM) and rewritable
- Large volume media – stores from 300 GB to 1.5 TB in a single data cartridge
- Virtually data migration free system
- Fast random file access to data files
- Easy-to-connect USB 3.0 interface
- Open Platform Architecture-Universal Disk Format (UDF)
- Supplied with "Content Manager" license

## Drive Roadmap

Sony has led the industry with advances in optical storage. Based on that extensive knowledge and expertise, we also continue to develop the rapidly increasing transfer rates and capacity for next generation in Optical Disc Archive drive.

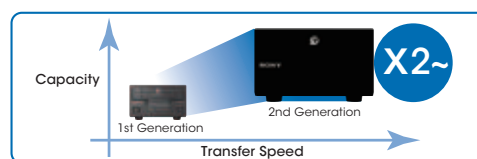

## Simple Management

A Content Manager software license is supplied with the drive for stand-alone usage.

- Simple graphical user interface to manage files easily
- Supports troublesome tasks including creating metadata
- Printing labels to improve efficiency
- Automatically generates proxy and thumbnail generation
- Supports a variety of formats for creating metadata
- MD5 checksum for archive data
- Import/export metadata created in the cartridge unit

User Interface



Support Format for creating Metadata

	File Format
XAVC	MXF
MPEG HD 422	MXF
MPEG HD 420	MXF
MPEG HD	MP4
AVCHD	MTS, M2TS
MPEG IMX	MXF
HDV	M2T (Windows), MOV (Mac)
DV	AVI (Windows), MOV (Mac)
ProRes	MOV
DNxHD	MOV

## System Example

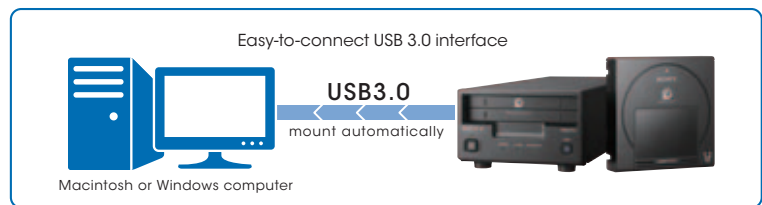

## Specifications

	ODS-D55U	ODS-D77U
Power Requirements	12 V DC (AC adaptor supplied)	
Power Consumption	20 W (Average)	
Operating Temperature	5°C to 40°C (41°F to 104°F)	
Storage Temperature	-20°C to +60°C (-4°F to +140°F)	
Mass	4 kg (8 lb 13 oz)	
Dimensions (W H D)	146 x 84 x 398 mm (5 3/4 x 3 3/8 x 15 3/4 inches) (excluding protrusion)	
Input/Output	Super Speed USB (USB3.0)	
Supplied Accessories	AC Adaptor (1), USB3.0 Cable (1), Operation Manual (1), Operation Manual CDROM (1), Serial Number Sheet for Contents Manager (1)	

ODS-D55U



Front Panel



Rear Panel

# Optical Disc Archive Library

## ODS-L10 10 Slots Library



### Recommended for

Broadcast stations

Production houses

Educational facilities

Museums, galleries

Houses of worship

### Easy and Efficient Archive Management with Mini Robotic Library

Sony has also introduced new robotic Optical Disc Archive products: the ODS-L10 compact robotic libraries. Suitable for various applications, they are specifically designed for users with small- to medium-scale production systems, where media assets are managed by multiple users.

## Main Features

- **Compact All-in-one Design**  
These new mini robotic libraries hold up to two Optical Disc Archive drives, a maximum of 10 cartridges (ODS-L10), and a built-in robotic mechanism in a 5U, 19-inch rack-mountable chassis.
- **Scalability**  
The ODS-L10 contains up to 10 cartridges, storing a maximum of 15 TB with ten ODC-1500R cartridges and you can use different cartridges per category or user.
- **High Reliability**  
The libraries support optional backup power supply units and Optical Disc Archive drives to ensure continuous operation in the unlikely event of one failing.
- **Easy to Connect**  
The ODS-L10 can be connected to a network via an Ethernet cable through a control PC with easy setup (IP address setting)

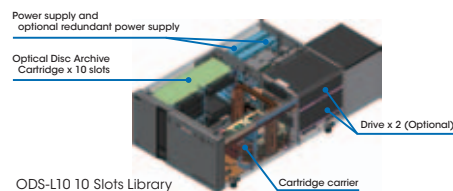



## File Manager

After File Manager software has been installed on a host computer, all operations can be controlled with a web-based GUI from each client computer.

- Web-based application for immediate use
- Can be accessed by up to five clients simultaneously
- Automated control of library robotic system
- Simple drag-and-drop operation to archive and retrieve files
- Off-line cartridge management on shelves
- Placeholder to archive together multiple files from different folders
- Add text metadata when archiving files
- Free text search
- Job priority management, job progress monitoring
- REST-based web service interface for integration with an external system

### User Interface

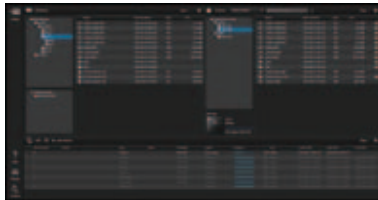

### System Requirements

Host Computer	
Processor	Intel Core i5 3 GHz or higher
Memory	4 GB or more
Hard disc Drive	1,500 GB (or more) of capacity for OS and DB 2,2 TB (or more) of cache space per drive; configuring RAID is recommended; you can also use other storage (NAS, etc.) as cache
OS	Windows 8 (or above), 64-bit
Port	2 x Ethernet port, 1 x USB3.0 port per drive
Client Computer	
Hardware	Any computer, provided common web browsers function correctly
OS*	Windows 7/8, 32-bit/64-bit Mac OS X (Lion/Mountain Lion)
Web browser*	Chrome 22 or above Internet Explorer 10 or above

\* These are verified for proper operation of the software.

## System Example

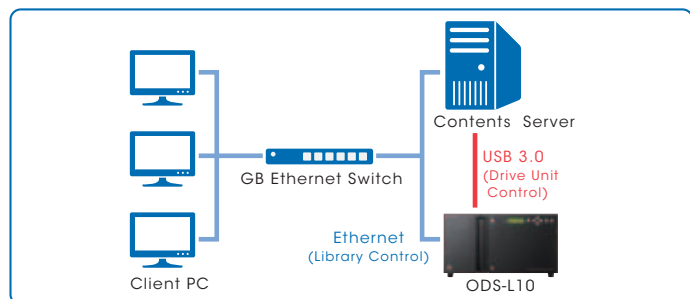

## Specifications

	ODS-L10
Maximum Number of Drives	2
Maximum Number of Cartridges	10
Max. Data Capacity	15 TB
Drive Interface	Super Speed USB (USB 3.0)
Library Control Interface	RJ-45 (x1), 1000BASE-T: IEEE 802.3ab, 100BASE-Tx: IEEE 802.3u
Power Requirements	100 V AC to 240 V AC, 50 Hz/60 Hz
Power Consumption	130W
Operating Temperature	5°C to 35°C (41°F to 95°F)
Storage Temperature	-20°C to +60°C (-4°F to +140°F)
Operating Humidity	20% to 90% (relative humidity)
Mass	27 kg (59 lb 8.4 oz) (not including drive units and cartridges)
Dimensions (W x H x D)	424 x 220 x 830 mm (16 3/4 x 8 3/4 x 32 3/4 inches) (excluding protrusions)
Supplied Accessories	File Manager license key sheet (1), Installation Manual (1), Operation Manual (1)

### ODS-L10



Front Panel

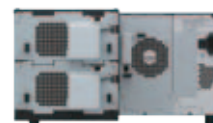

Rear Panel

# Optical Disc Archive PetaSite™, Scalable Library

- ODS-L30M Master Unit
- ODS-L60E Extension Unit (Drive and Cartridge)
- ODS-L100E Extension Unit (Cartridge only)



## Advantages

- Fully scalable
- Automated failover of library control path
- Co-existence of automated library operation and offline shelf management
- High performance of end-to-end operation
- Best solution for partial retrieve
- Interoperability between library and standalone drive
- File format-agnostic

## Expandable with up to 5 Extension Units

The ODS-L30M forms the basis of the PetaSite, Scalable Library that is easily scalable with ODS-L60E (Drive and Cartridge) and ODS-L100E (Cartridge only) extension units.

The ODS-L60E extends the PetaSite, Scalable Library operating alongside the ODS-L30M and ODS-L100E (Cartridge only) expansion units.

The ODS-L100E extends the PetaSite, Scalable Library operating alongside the ODS-L30M and ODS-L60E (Drive and Cartridge) expansion units.

A total of up to five expansion units maximum can attach to the ODS-L30M to make a single 42U library offering a maximum of 535 cartridges (802.5 TB), depending on the extension units used.

## Flexible System Expansion

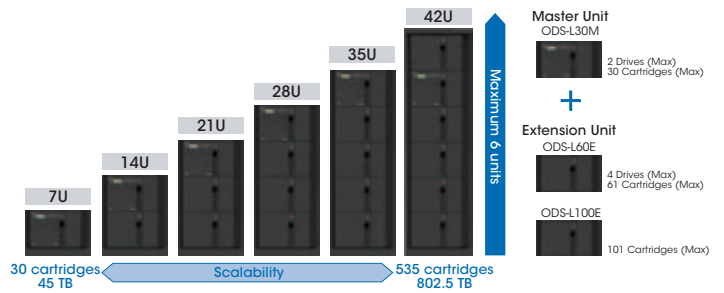

## Ideal for Deep and Near-online Archives

Sony's Optical Disc Archive system is ideal as a deep archive for very long-term archiving, such as broadcaster archives where data tape does not provide the assurance or meet the need for write-once, very long-term archive requirements. It can provide a second-copy archive at remote sites, and is ideal for business continuity/disaster recovery, post-house and post-production backup and for video, film, and stock footage archives or national archives. The system can also be used for news and sports clips that need to be near-online, and as an online browse and proxy clip store.

## System Example

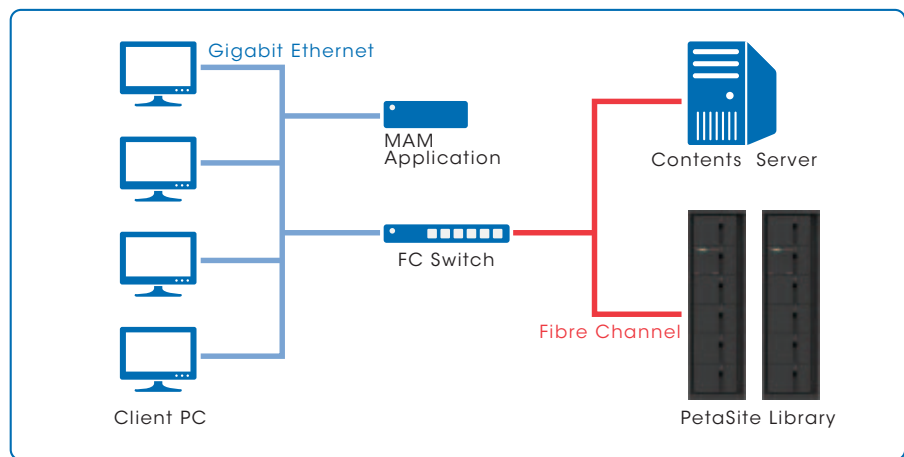

## Specifications

	ODS-L30M	ODS-L60E	ODS-L100E
Maximum Number of Drives	2	4	0
Maximum Number of Cartridges	30	61	101
Max. Data Capacity	45 TB	91.5 TB	151.5 TB
Host Interface	Fibre Channel 8Gbps		
Maintenance Interface	Gigabit Ethernet		
Power Requirements	100 V AC to 240 V AC, 50 Hz/60 Hz		
Power Consumption	312 W	300 W	-
Operating Temperature	5°C to 35°C (41°F to 95°F)		
Operating Humidity	20% to 80% (relative humidity)		
Mass	30 kg (66 lb 2.2 oz) (not including drive units and cartridges)		
Dimensions (W x H x D)	445 x 308 x 940 mm (17 5/8 x 12 1/4 x 37 1/8 inches) (excluding protrusions)		





Optical Disc Archive

Distributed by

©2013 Sony Corporation. All rights reserved.  
Reproduction in whole or in part without written permission is prohibited.  
Features, design, and specifications are subject to change without notice.  
The values for mass and dimension are approximate.  
"SONY", "Petasite", and "XAVC" are trademarks of Sony Corporation.  
All other trademarks are the property of their respective owners.

MK11054V1DNP13AUG